



db

teknik
katalog

www.abka.net



Mazgal ve Oluk Kullanım Alanları

- ➔ Stad içi drenaj uygulaması
- ➔ Yeşil alan ve bahçe drenaj uygulaması
- ➔ Garaj ve otopark uygulaması
- ➔ Havuz kenarı drenaj uygulaması



Kasımpaşa Stadi
Yer Sistemleri

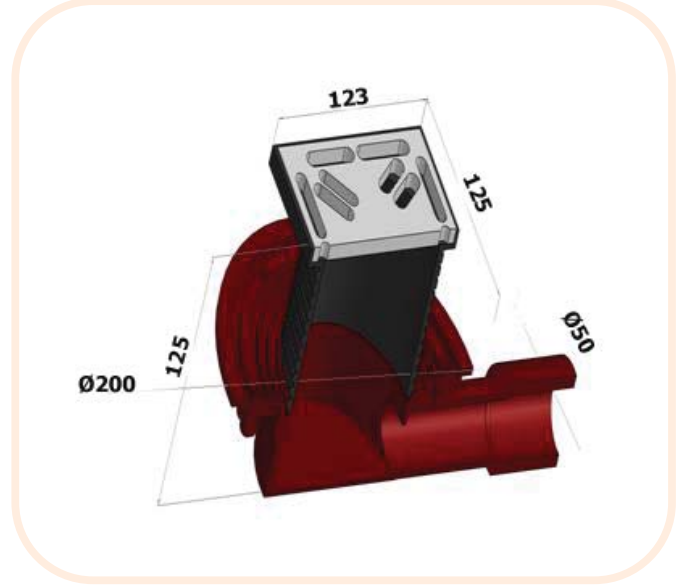

Yandan çıkışlı yer süzgeci, DN40/50 çıkışlı, kapama suyu yüksekliği 30 mm, kısaltılabilir gövdeli 12-70 mm, 123x123 mm çerçevesi, 115x115 mm özel paslanmaz çelik ızgaralı, **montaj yüksekliği 57 mm**, maksimum 300 kg, 0,43.L/sn su taşıma kapasiteli.

Ürüne İlave Edilebilir Parçalar

- AB 1** Süzgeç başlığı (gövde) d110 mm / 123x123 mm çerçevesi, 115x115 mm paslanmaz çelik ızgaralı
- AB 2** Süzgeç gövdesi d110 mm / 90 mm 123x123 mm
- AB 3** Koruyucu kapak 123x123 mm
- AB 4** Izgara, paslanmaz çelik 115x115 mm
- AB 5** Balkon ve teras süzgeci gövdesi DN 40/50 yatay
- AB 110** İzolasyon flanşı

Teknik Özellikler

Malzeme	: PE/PP
Ölçü	: DN 40/50
Akış Yüğü	: 0,43 L/sn
Ağırlık	: 0.747 kg
Yük Kapasitesi	: 300 kg
Montaj Yüksekliği	: 93 mm
Gövde	: 12-70 mm / 123x123 mm

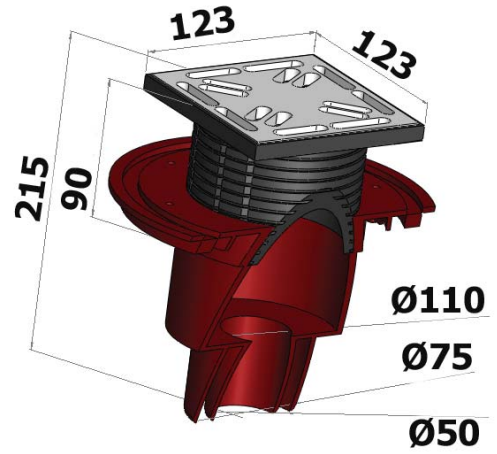

Alttan çıkışlı yer süzgeci, DN 50/70/100 çıkışlı, 123x123 mm özel paslanmaz çelik ızgaralı, kısaltılabilir gövdeli 12-70 mm, maksimum 300 kg, 0,50 L/sn. su taşıma kapasiteli.

Ürüne İlave Edilebilir Parçalar

- AB 1** Süzgeç başlığı (gövde) d110 mm / 123x123 mm çerçevesi, 115x115 mm paslanmaz çelik ızgaralı
- AB 2** Süzgeç gövdesi d110 mm / 90 mm 123x123 mm
- AB 3** Koruyucu kapak 123x123 mm
- AB 4** Iızgara, paslanmaz çelik 115x115 mm
- AB 6** Balkon ve teras süzgeci gövdesi DN 50/70/100 dikey
- AB 110** İzolasyon flanşı

Teknik Özellikler

Malzeme	: PE/PP
Ölçü	: DN 50/70/100
Akış Yüğü	: 0,50 L/sn
Ağırlık	: 0.750 kg
Yük Kapasitesi	: 300 kg
Montaj Yüksekliğı	: 158 mm
Gövde	: 12-70 mm / 123x123 mm

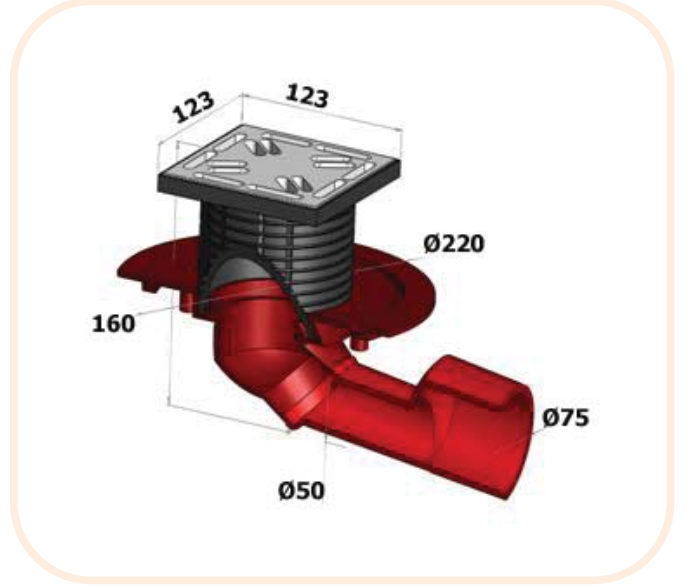

Mafsallı balkon ve teras süzgeci, DN 50/70 yataydan dikeye kademesiz ayarlanabilir çıkışlı, 123x123 mm çerçeveli, 115x115 mm özel paslanmaz çelik ızgaralı, kısaltılabilir gövdeli 12-70 mm, maksimum 300 kg 0,48.L/sn. su taşıma kapasiteli.

Ürüne İlave Edilebilir Parçalar

- AB 1** Süzgeç başlığı (gövde) d110 mm / 123x123 mm çerçeveli, 115x115 mm paslanmaz çelik ızgaralı
- AB 2** Süzgeç gövdesi d110 mm / 90 mm 123x123 mm
- AB 3** Koruyucu kapak 123x123 mm
- AB 4** Izgara, paslanmaz çelik 115x115 mm
- AB 7** Balkon ve teras süzgeci gövdesi DN 50/70 mafsallı
- AB 110** İzolasyon flanşı

Teknik Özellikler

Malzeme	: PE/PP
Ölçü	: DN 50/70
Akış Yüğü	: 0,48 L/Sn.
Ağırlık	: 0,547 kg
Yük Kapasitesi	: 300 kg
Montaj Yüksekliği	: 103 mm
Gövde	: 12-70 mm / 123x123 mm

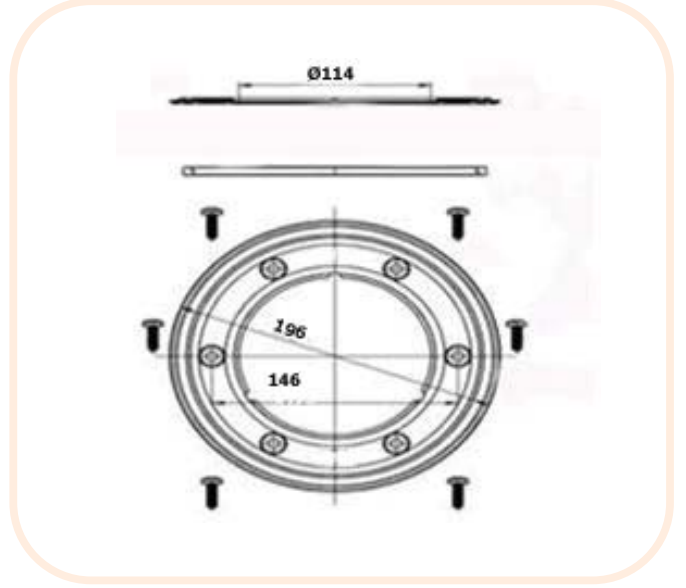

İzolasyon takımı, 196x114 mm vidalı, paslanmaz çelik flanş ve Dudak Conta dahil AB1010, AB1020 ve AB1030 kodlu süzgeçler için uygundur.

Ürüne İlave Edilebilir Parçalar

- AB 1111** Dudak Conta 180x6 mm
- AB 1112** Paslanmaz vida 6,3x16 mm (6 adet)
- AB 1113** Paslanmaz çelik flanş 200x115 mm

Teknik Özellikler

- Malzeme** : Paslanmaz çelik (vida dahil)
- Ölçü** : 196x114 mm
- Ağırlık** : 0,245 kg

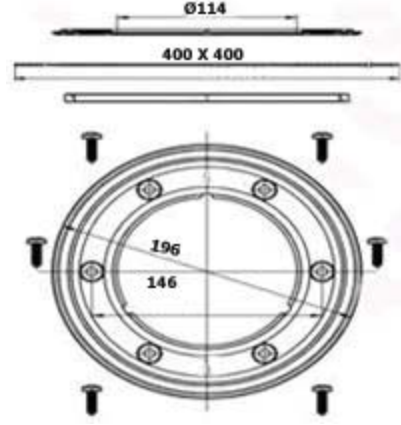
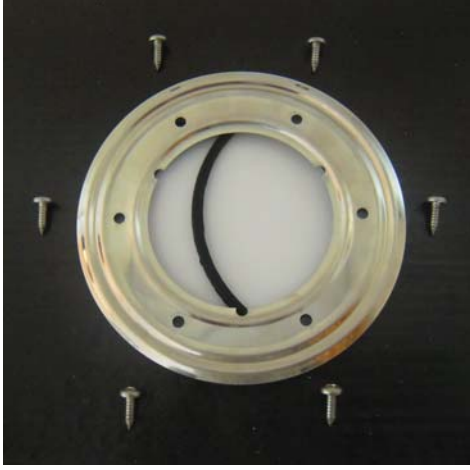

İzolasyon takımı, 196x114 mm vidalı, paslanmaz çelik flanş ve Dudak Conta ve EPDM dahil AB1010, AB1020 ve AB1030 kodlu süzgeçler için uygundur.

Ürüne İlave Edilebilir Parçalar

- AB 1111** Dudak Conta 180x6 mm
- AB 1112** Paslanmaz vida 6,3x16 mm (6 adet)
- AB 1113** Paslanmaz çelik flanş 200x115 mm
- AB 1114** EPDM folye 400x400 mm

Teknik Özellikler

- Malzeme** : Paslanmaz çelik (vida dahil) - EPDM
- Ölçü** : 196x114 mm / d 400 mm
- Ağırlık** : 0,425 kg

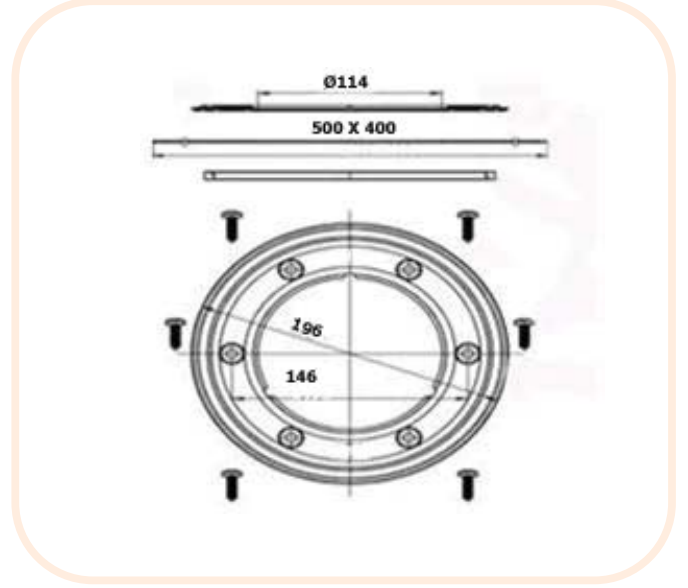

İzolasyon takımı, 196x114 mm vidalı, paslanmaz çelik flanş ve Dudak Conta ve su geçirimsiz derz bandı dahil AB1010, AB1020 ve AB1030 kodlu süzgeçler için uygundur.

Ürüne İlave Edilebilir Parçalar

- AB 1111** Dudak Conta 180x6 mm
- AB 1112** Paslanmaz vida 6,3x16 mm (6 adet)
- AB 1113** Paslanmaz çelik flanş 200x115 mm
- AB 1115** 0,3 mm beyaz su geçirimsiz derz bandı 500x400 mm

Teknik Özellikler

- Malzeme** : Paslanmaz çelik (vida dahil) - 0,3 mm kalınlığında beyaz su geçirimsiz derz bandı
- Ölçü** : 196x114 mm / d 400 mm
- Ağırlık** : 0,125 kg
- İzolasyon Bandı** : Polipropilen esaslı poliüretan film takviyeli kompozit bir donatı takviyedir. Fayansların altında ve izolasyon malzemelerinin içinde kullanabilen, su geçirmeyen ve çatlakları önleyen banttır. -20° C'den, +90° C'ye kadar dayanıklıdır.

Ab 1300



Altan çıkışlı yer süzgeci, DN50/70/100 Çıkışlı 123x123mm çerçevesi, 115x115 mm özel paslanmaz çelik ızgaralı kısaltılabilir gövdeli 12-70 mm, maksimum 300 kg, 0,50.L/sn. Su taşıma kapasiteli. Farkı bitüm izolasyonlu olması.

Ab 1310

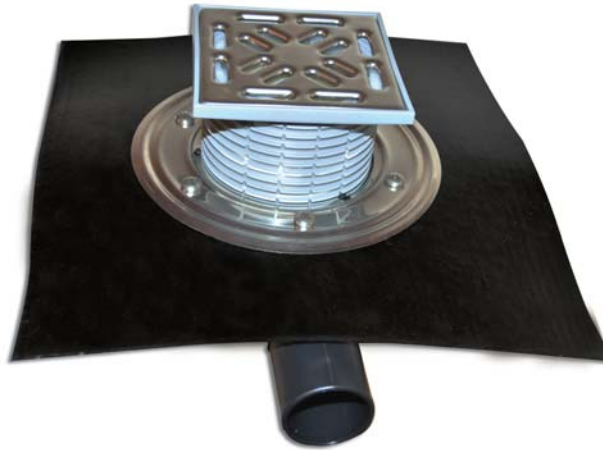

Altan çıkışlı yer süzgeci, DN40/50 çıkışlı kapama suyu yüksekliği 30 mm, kısaltılabilir gövdeli 12-70mm, 123x123 mm çerçevesi, 115x115mm özel paslanmaz çelik ızgaralı, **Montaj Yüksekliği 57 mm**, maksimum 300 kg, 0,43.L/sn. Su taşıma kapasiteli. Farkı bitüm izolasyonlu olması.

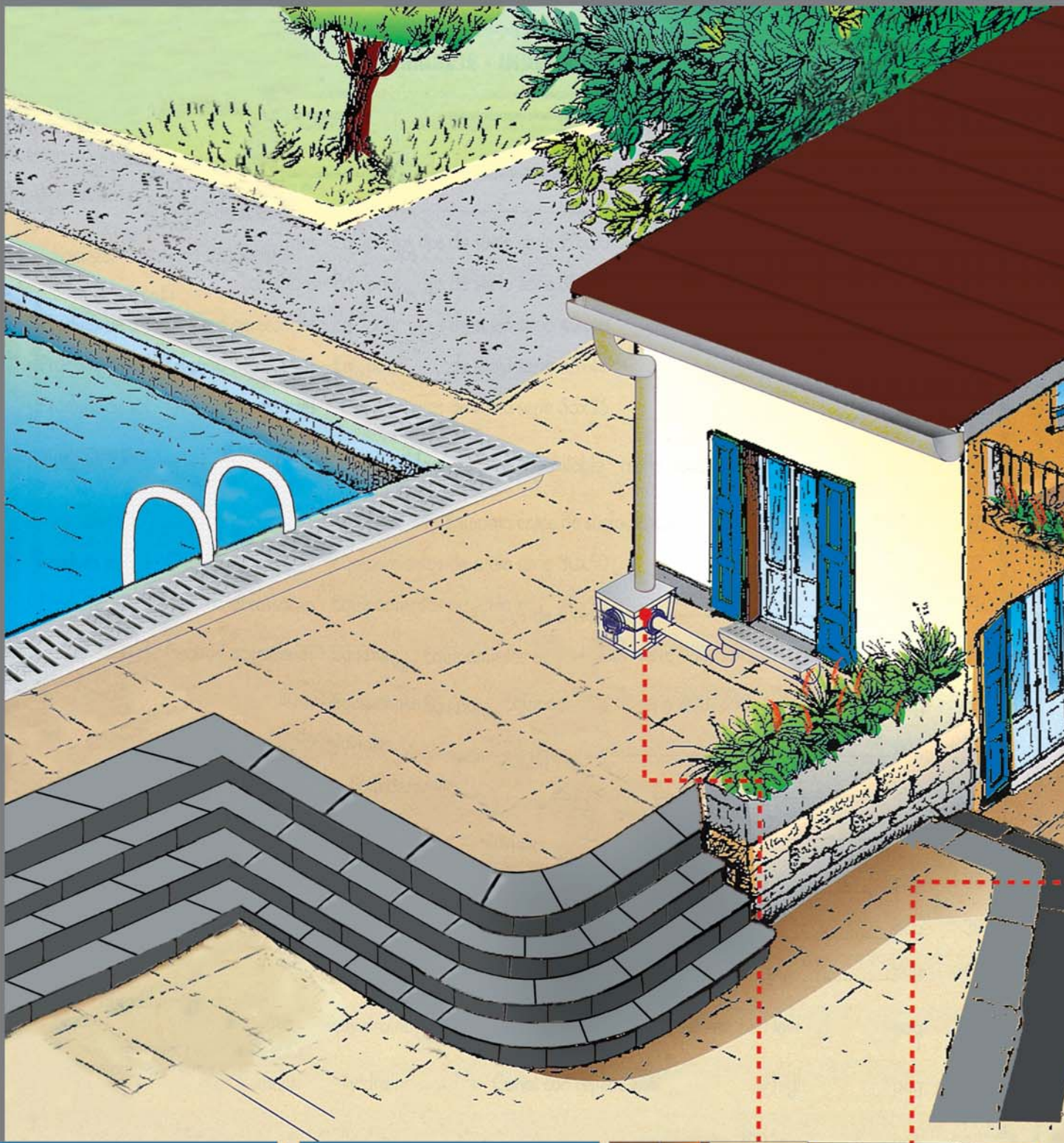

SÜZGEÇ



AB 1010

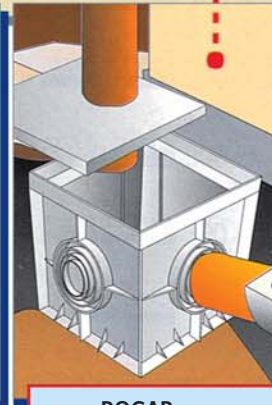

ROGAR



AB 1020

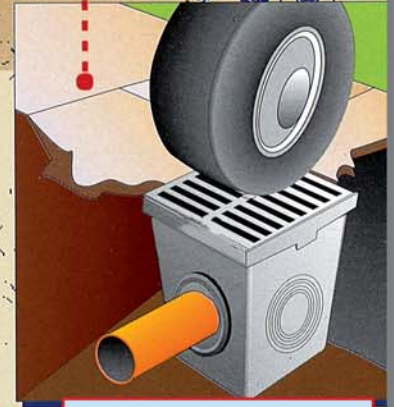
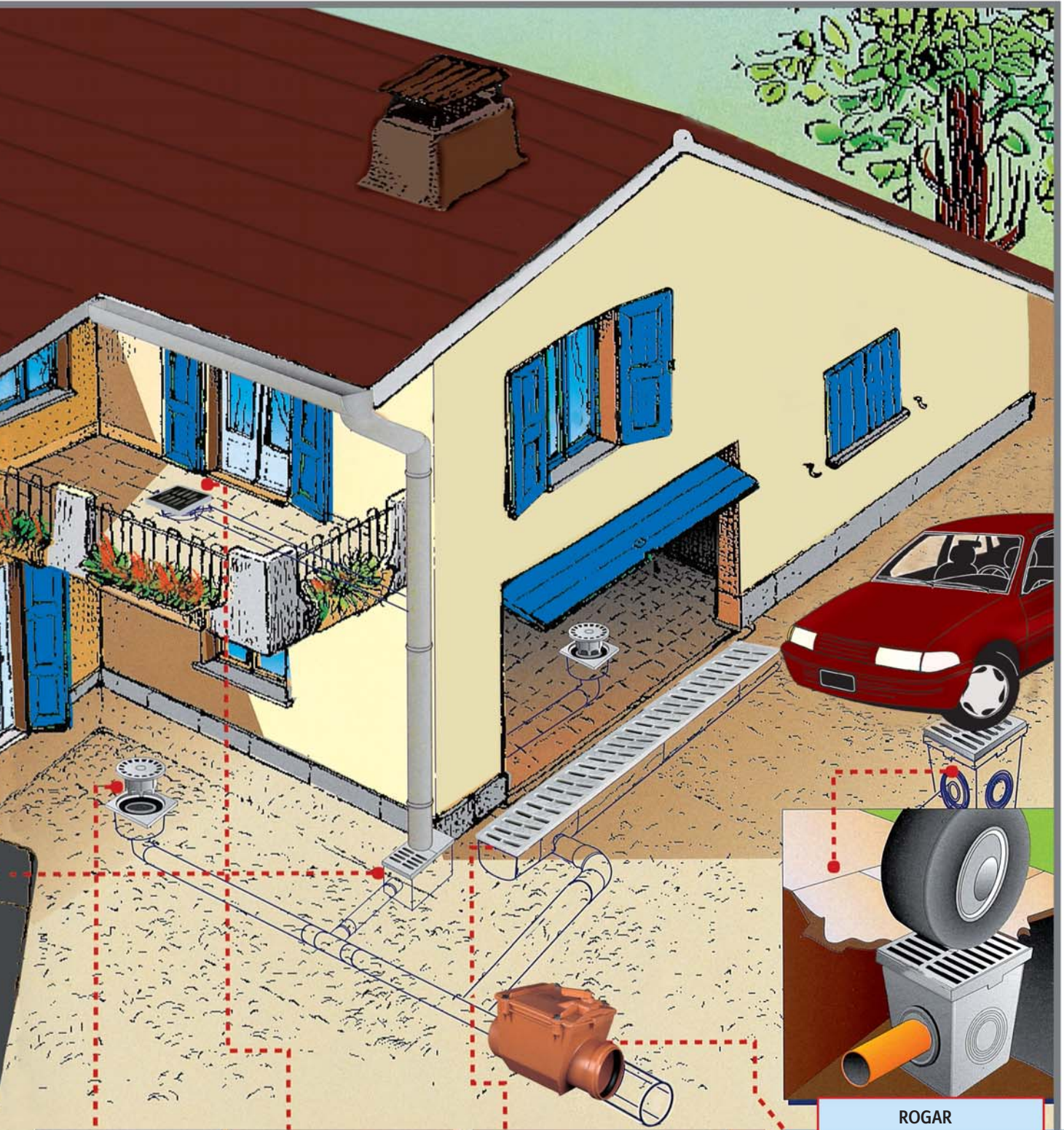

ROGAR



DÖŞEME SÜZGEÇLERİ



MAZGAL ve OLUK



ÇEKVALF

Ab 1350

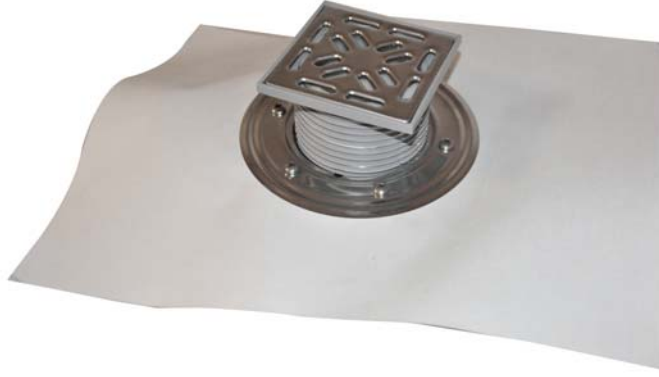







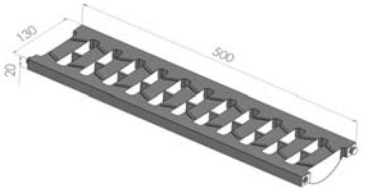

Altan çıkışlı yer süzgeci, DN50/70/100 çıkışlı 123x123mm çerçevesi, 115x115mm özel paslanmaz çelik ızgaralı kısaltılabilir gövdeli 12-70mm, maksimum 300 kg, 0,50.L/sn. Su taşıma kapasiteli. Farkı su geçirimsiz derz bandı montajlı olması.

Ab 1360

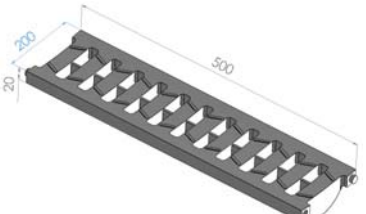



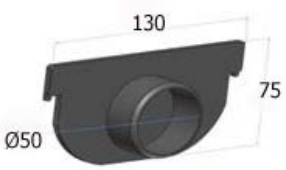

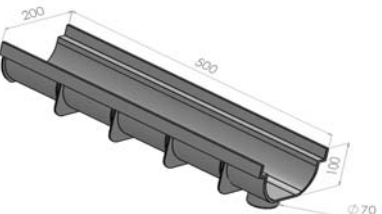









Altan çıkışlı yer süzgeci, DN40/50 çıkışlı kapama suyu yüksekliği 30 mm, kısaltılabilir gövdeli 12-70mm, 123x123mm çerçevesi, 115x115mm özel paslanmaz çelik ızgaralı, **Montaj Yüksekliği 57 mm**, maksimum 300 kg, 0,43.L/sn. Su taşıma kapasiteli. Farkı su geçirimsiz derz bandı montajlı olması.



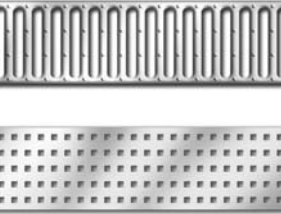
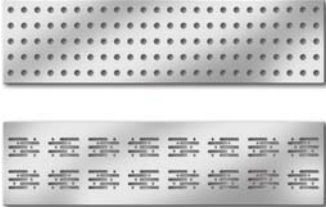

RESİM	TEKNİK ÇİZİM	KOD	ÖLÇÜ	AÇIKLAMA
		AB 100	10x10	PP Süzgeç Ø50 Yandan Çıkışlı
		AB 110	10x10	Krom Görünümlü Izgara Ø50 Yan Çıkışlı
		AB 120	15x15	PVC Süzgeç Ø50 Altdan Çıkışlı
		AB 130	20x20	PVC Süzgeç Ø70 Altdan Çıkışlı
		AB 140	20x20	PVC Süzgeç Ø70 Yandan Çıkışlı
		AB 150	25x25	PVC Süzgeç Ø100 Altdan Çıkışlı

RESİM	TEKNİK ÇİZİM	KOD	ÖLÇÜ	AÇIKLAMA
		AB 200	130x500	PVC Mazgal (2,5 Ton Taşıma Kapasiteli)
		AB 250	200x500	PVC Mazgal (1,5 Ton Taşıma Kapasiteli)
		AB 210	130x75x500	Mazgal Oluğu
		AB 200	130	Oluk Tapası
		AB 230		Köşe Parça 90° (Takım)
		AB 260	200x100x500	Mazgal Oluğu

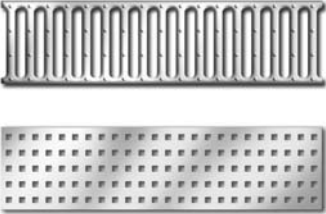
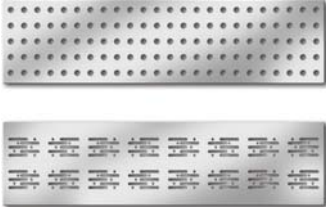
RESİM	TEKNİK ÇİZİM	KOD	ÖLÇÜ	AÇIKLAMA																			
		AB 270	200	Oluk Tapası																			
		AB 280		Köşe Parça 90° (Takım)																			
	<p>KOD: PPKC0110 (Ø110 İÇİN) / PPKC0125 (Ø125 İÇİN) KİLİTLİ VILLA TİPİ PASLANMAZ ÇEKVALF</p> <p>PP KİLİTLİ ÇEKVALF BOYUTSAL ÖLÇÜLERİ</p> <table border="1"> <thead> <tr> <th>Ø</th> <th>L</th> <th>H</th> <th>G</th> </tr> </thead> <tbody> <tr> <td>110</td> <td>285</td> <td>224</td> <td>185</td> </tr> <tr> <td>125</td> <td>300</td> <td>224</td> <td>185</td> </tr> </tbody> </table>	Ø	L	H	G	110	285	224	185	125	300	224	185	AB 300	Ø 100 mm Paslanmaz Klapeli Kilitli Çekvalf								
		Ø	L	H	G																		
110	285	224	185																				
125	300	224	185																				
AB 310	Ø 125 mm Paslanmaz Klapeli Kilitli Çekvalf																						
	<p>KOD: PVCCV0110 (Ø110 İÇİN) / PVCCV0125 (Ø125 İÇİN) PVCCV0160 (Ø160 İÇİN) / PVCCV0200 (Ø200 İÇİN) KAPAKLI TİP PASLANMAZ ÇEKVALF</p> <p>PVC KAPAKLI ÇEKVALF BOYUTSAL ÖLÇÜLERİ</p> <table border="1"> <thead> <tr> <th>Ø</th> <th>L</th> <th>H</th> <th>G</th> </tr> </thead> <tbody> <tr> <td>110</td> <td>300</td> <td>270</td> <td>235</td> </tr> <tr> <td>125</td> <td>300</td> <td>270</td> <td>235</td> </tr> <tr> <td>160</td> <td>310</td> <td>270</td> <td>235</td> </tr> <tr> <td>200</td> <td>465</td> <td>270</td> <td>235</td> </tr> </tbody> </table>	Ø	L	H	G	110	300	270	235	125	300	270	235	160	310	270	235	200	465	270	235	AB 350	Ø 100 mm Paslanmaz Klapeli Tem. Kilitli Çekvalf
		Ø	L	H	G																		
		110	300	270	235																		
		125	300	270	235																		
160	310	270	235																				
200	465	270	235																				
AB 360	Ø 125 mm Paslanmaz Klapeli Tem. Kilitli Çekvalf																						
AB 370	Ø 150 mm Paslanmaz Klapeli Tem. Kilitli Çekvalf																						
AB 380	Ø 200 mm Paslanmaz Klapeli Tem. Kilitli Çekvalf																						
	<p>KOD: PVCKC0160 (Ø160 İÇİN) / PVCKC0200 (Ø200 İÇİN) KİLİTLİ TİP PASLANMAZ ÇEKVALF</p> <p>PVC KİLİTLİ ÇEKVALF BOYUTSAL ÖLÇÜLERİ</p> <table border="1"> <thead> <tr> <th>Ø</th> <th>L</th> <th>H</th> <th>G</th> </tr> </thead> <tbody> <tr> <td>160</td> <td>310</td> <td>270</td> <td>235</td> </tr> <tr> <td>200</td> <td>465</td> <td>270</td> <td>235</td> </tr> </tbody> </table>	Ø	L	H	G	160	310	270	235	200	465	270	235	AB 320	Ø 150 mm Paslanmaz Klapeli Kilitli Çekvalf								
		Ø	L	H	G																		
160	310	270	235																				
200	465	270	235																				
AB 330	Ø 200 mm Paslanmaz Klapeli Kilitli Çekvalf																						

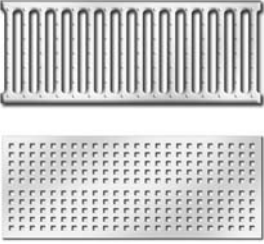
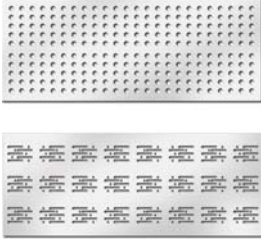
RESİM	TEKNİK ÇİZİM	KOD	ÖLÇÜ	AÇIKLAMA
		AB 400	200x200	PP Rogar
		AB 410	300x300	PP Rogar
		AB 420	400x400	PP Rogar
		AB 430	500x500	PP Rogar
		AB 440	20x20	Dolu Kapak
		AB 450	30x30	Dolu Kapak
		AB 460	40x40	Dolu Kapak
		AB 470	50x50	Dolu Kapak
		AB 480	20x20	Izgara Kapak
		AB 490	30x30	Izgara Kapak
		AB 500	40x40	Izgara Kapak
		AB 510	50x50	Izgara Kapak
		AB 560	Dere İçin	Ahtapot 150-200 Çık.
		AB 570		Profilden 75 mm Boruya Geçiş
		AB 580		Profilden 110 mm Boruya Geçiş
		AB 590		75 mm Borudan Profile Geçiş Geçiş
		AB 600		110 mm Borudan Profile Geçiş Geçiş
		AB 610	110 mm	Köşe Balkon Süzgeci

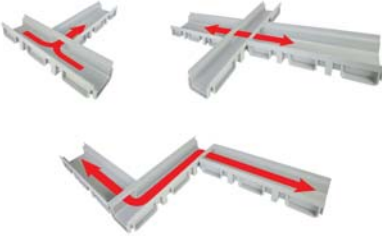
RESİM	TEKNİK ÇİZİM	KOD	ÖLÇÜ	AÇIKLAMA
 <p>Yeni Ürün</p>				AB 5, AB 6 ve AB7 Gövde İçin Plastik Yaprak Tutucu Üst Parça
 <p>Yeni Ürün</p>			10x10	Ø32 Yandan Çıkışlı Plastik Gövdeli ve Palanmaz Izgaralı Süzgeç
 <p>Yeni Ürün</p>			10x10	Ø50 Yandan Çıkışlı Plastik Gövdeli ve Palanmaz Izgaralı Süzgeç
 <p>Yeni Ürün</p>			10x10	Ø32 Yandan Çıkışlı Plastik Gövdeli ve Palanmaz Izgaralı Süzgeç
 <p>Yeni Ürün</p>			10x10	Ø50 Yandan Çıkışlı Plastik Gövdeli ve Palanmaz Izgaralı Süzgeç
 <p>Yeni Ürün</p>			130x150	130 mm Paslanmaz Izgara

RESİM	TEKNİK ÇİZİM	KOD	ÖLÇÜ	AÇIKLAMA
			200x500	200 mm Paslanmaz Izgara
Yeni Ürün				
			130x500 200x500	Muzgal Oluđu
Yeni Ürün				
			130 mm 200 mm	Oluk Tapası

Susuz Çalışabilen Koku Önleyicili Süzgeçler

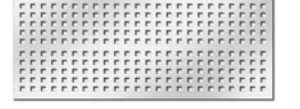
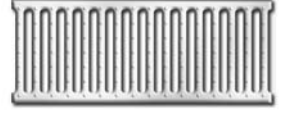



www.abka.net

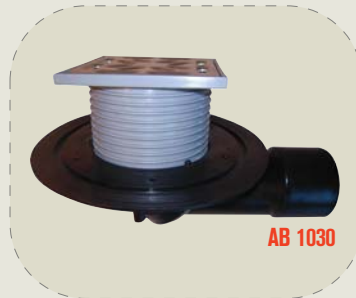
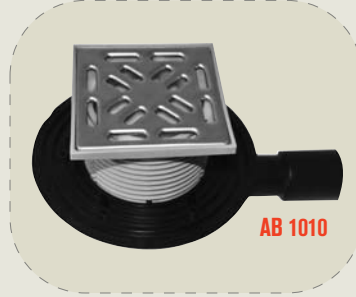

Bostancı Yolu Cd. Eryılmaz Sk. No: 28/4
Y.Dudullu - Ümraniye - İstanbul
T: +90 (216) 364 3 364
F: +90 (216) 313 46 46